

Antenna FIA06-80S18D-M

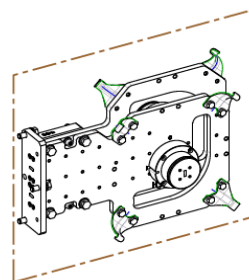
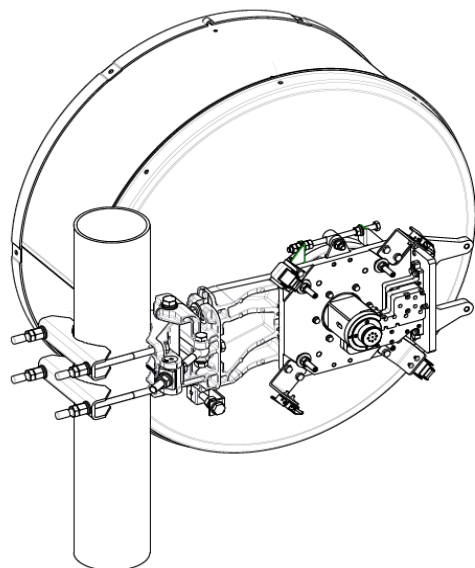

OPTIONAL MODULE
FOR ODU DIRECT MOUNT
VARIOUS RADIO VENDORS

General Specifications

Diameter	0.6 m
Standard Colour	White
Antenna Input	Two rectangular ports @ 18 GHz / One rectangular port @ 80 GHz. Interfaces are customized according to Customer's specifications
Polarization	Linear Dual pol. (V / H) @ 18 GHz, Linear Single pol. @ 80 GHz.

Mechanical Characteristics

Pole	50 ÷ 114 mm
Elevation-fine adjustment	± 15°
Azimuth-fine adjustment	± 20°
Side struts, included	0
Side struts, optional	0
Net weight	18 Kg
Radome	Rigid Plastic
Wind velocity Operational (1,2)	45 m/s
Wind velocity Survival Rating (1,3)	70 m/s

(1) maximum wind ratings apply at the antenna installed on a 114mm dia. pole

(2) antenna deflection < 0.3 times the -3 dB beam width

(3) wind speed applicable to the antenna with 25mm of radial ice



Antenna Dimensions^(*) (pole mount included)

Height	652 mm
Width (**)	857 mm
Depth	405 mm

(*) referred to a 114 mm dia. pole

(**) including optional extension bracket for ODU's direct mount

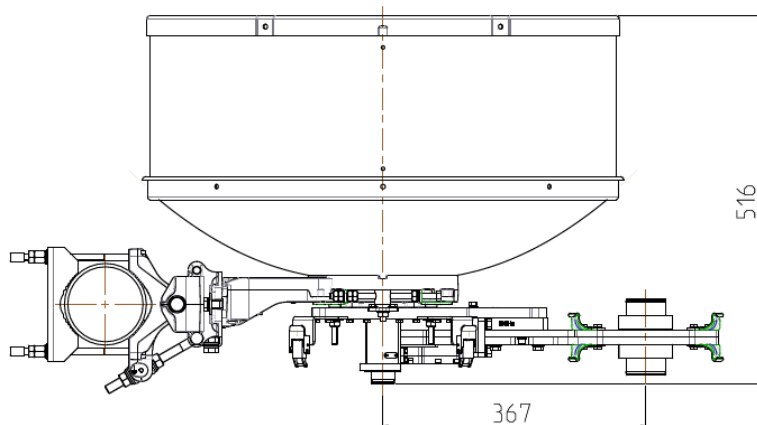
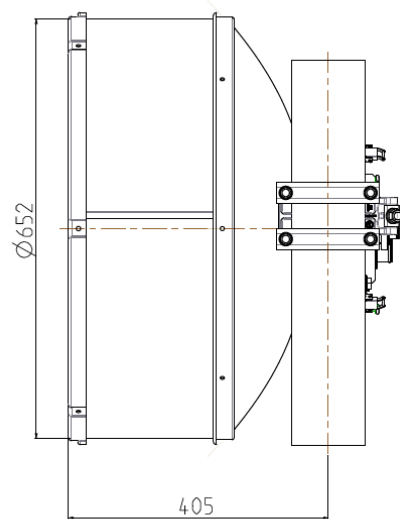
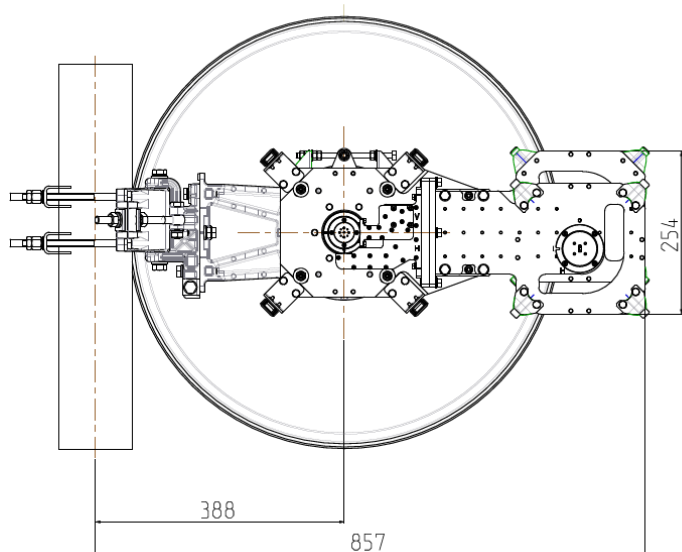

Wind forces at wind velocity survival rating and with 25 mm (1") ice load

Axial force	1444 N
Side force	715 N
Twisting moment	527 N m

Maximum forces exerted on a supporting structure as a result of wind (survival rating) from the most critical direction for each parameter. These values may not occur simultaneously. All forces are referred to the mounting pipe of 115 mm diameter.

Electrical Characteristics

Frequency range	17.7-19.7 GHz / 71-86 GHz
Gain, mid band @ 18 GHz	38 dBi
Gain, mid band @ 80 GHz	50 dBi
R.L.	14 dB
V.S.W.R.	1.5:1
Inter port Isolation 18 - 80 GHz	20 dB
HPBW	1.6° (@18 GHz) / 0.4° (@80 GHz)
Front-to-back ratio	65 dB (@18 GHz) / 67 dB (@80 GHz)
Isolation @ 18 GHz	35 dB
XPD	30 dB (@18 GHz) / 27 dB (@ 80 GHz)
Electrical Compliance	ETSI 302 217 Class 3

Shipping Information

Gross weight	20 Kg
Height	520 mm
Width	750 mm
Depth	750 mm

