

Antenna HP 20-107 D

 Antenna HP 20-107 D



▾ General Specifications

Diameter	2.0 m
Standard Colour	RAL 7030
Shroud	Standard profile
Antenna Input	Interface for IEC waveguide R 100
Polarization	Dual

▾ Mechanical Characteristics

Pole	115 mm
Elevation-fine adjustment	±5°
Azimuth-fine adjustment	±5°
Side struts, included	2
Side struts, optional	0
Net weight	211 Kg
Radome	Complan fabric
Wind velocity Operational	30 m/s
Wind velocity Survival	55 m/s
Wind deflection	<0.3 times the -3 dB beamwidth
(with a wind velocity of 30 m/s)	Specified wind deflection applies for 115 mm dia mounting pipe only

↙ Antenna Dimensions

(pole mount included)

Height 2145 mm

Width 2145 mm

Depth 1420 mm

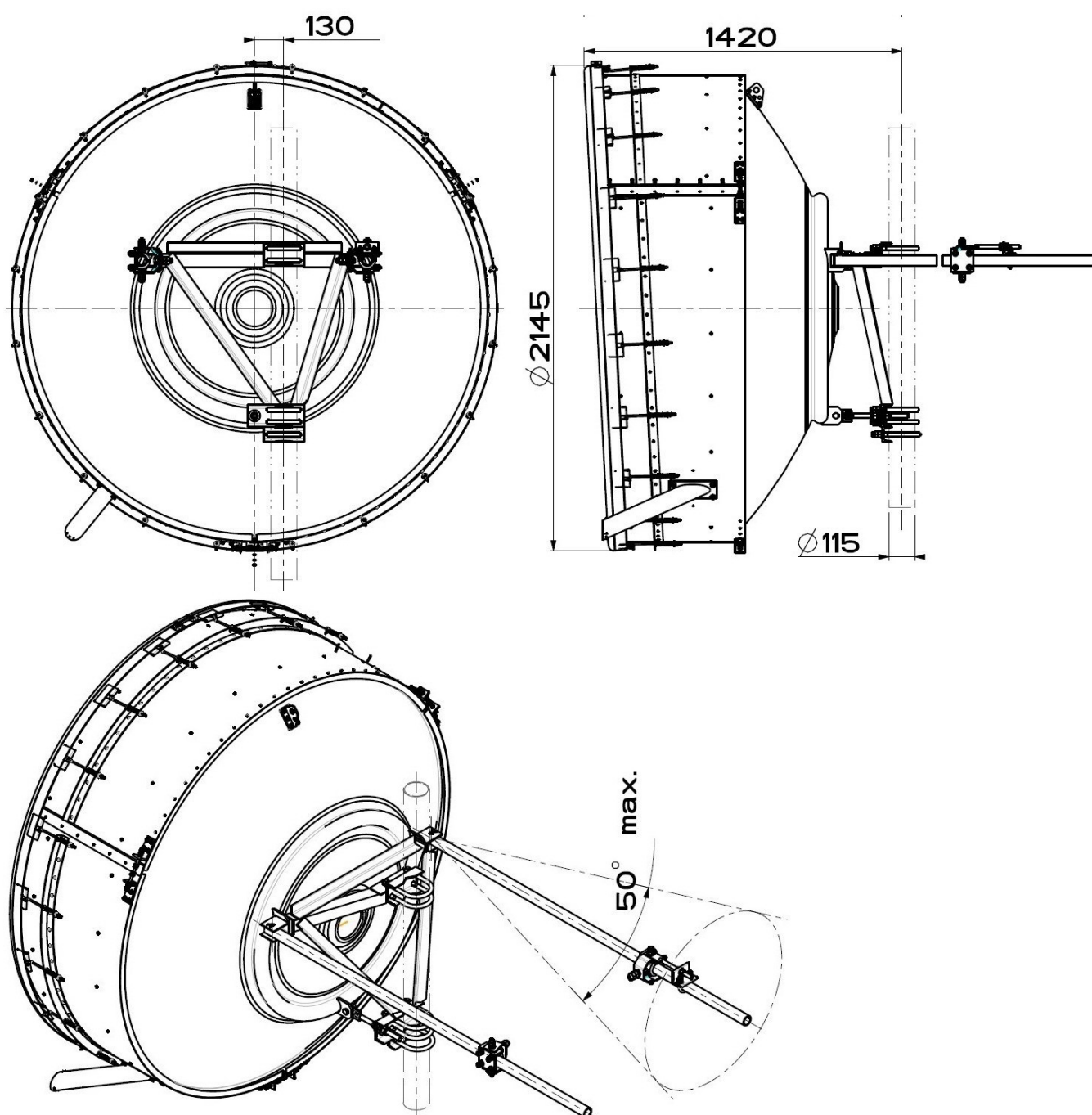

↘ Wind forces at wind velocity survival rating and with 25 mm (1") ice load

Axial force	8720 N
Side force	4320 N
Twisting Moment	3280 N?m

Maximum forces exerted on a supporting structure as a result of wind (survival rating) from the most critical direction for each parameter. These values may not occur simultaneously. All forces are referenced to the mounting pipe (diameter 115 mm)

↘ Electrical Characteristics

Frequency range	10.7-10.7 GHz
Gain, low band	44.2 dBi
Gain, mid band	44.6 dBi
Gain, top band	44.9 dBi
Return Loss	30.7 dB
VSWR	1.06
HPBW	1.0°
Front to back ratio	70 dB
Isolation	40 dB
XPD	30 dB
Electrical Compliance	Class 3

↘ Shipping Information

Gross weight	340 Kg
Height	2400 mm
Depth	2170 mm
Width	900 mm

