

Antenna THP 03 127 D

Antenna THP 03 127 D



▾ General Specifications

Diameter	0.3m
Standard Colour	RAL 7035
Shroud	Low profile
Antenna Input	Interface for IEC waveguide R 120
Polarization	Dual

▾ Mechanical Characteristics

Pole	50-115 mm
Elevation-fine adjustment	+/- 15 deg
Azimuth-fine adjustment	+/- 20 deg
Side struts, included	0
Side struts, optional	0
Net weight	9 Kg
Radome	Rigid plastic
Wind velocity Operational	45 m/s
Wind velocity Survival	70 m/s
Wind deflection	<0.3 times the -3 dB beam width
(with a wind velocity of 45 m/s)	Specified wind deflection applies for 115 mm dia mounting pipe only

↙ Antenna Dimensions

(pole mount included)

Height 385 mm

Width 586 mm

Depth 219 mm

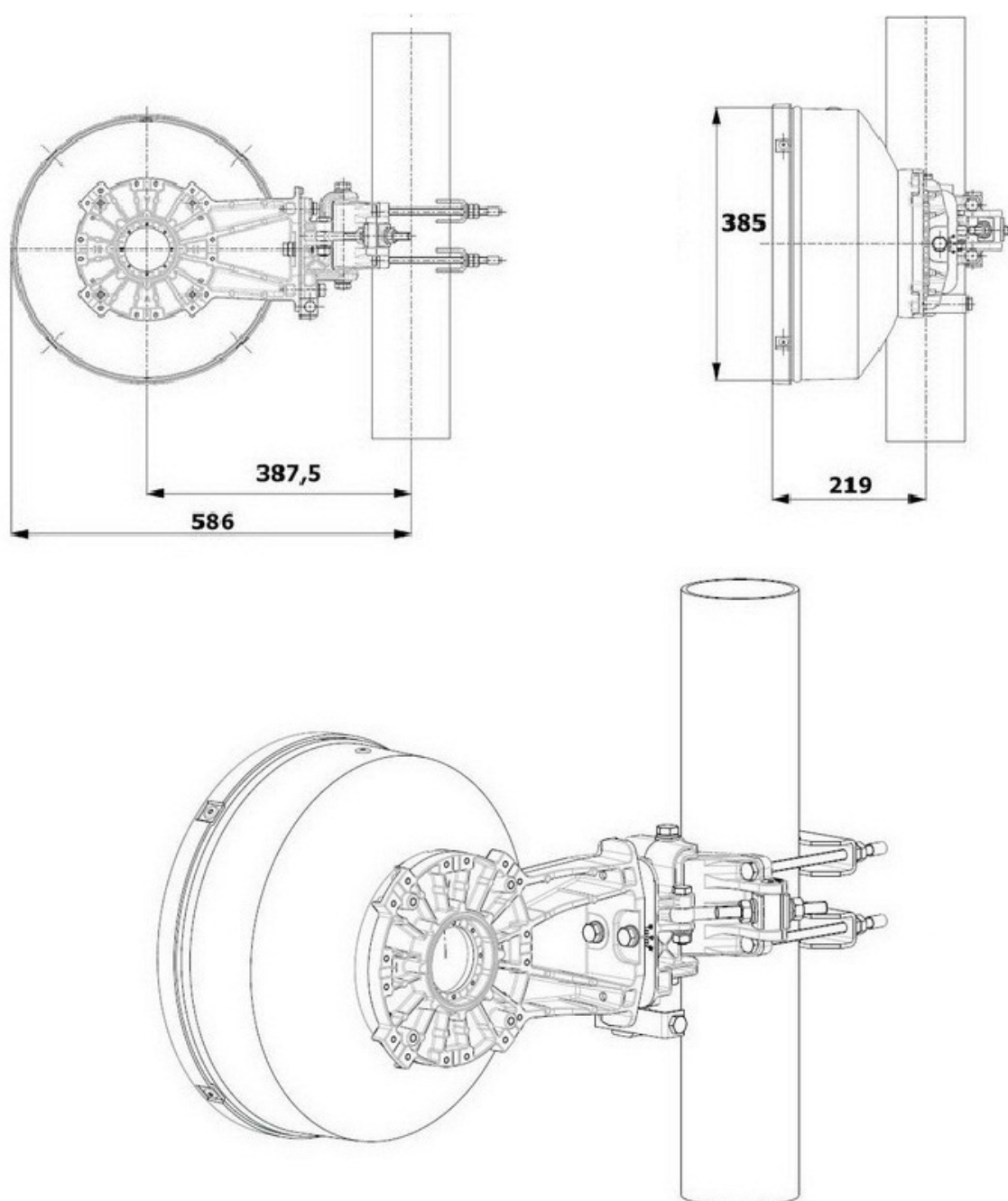

↘ Wind forces at wind velocity survival rating and with 25 mm (1") ice load

Axial force	472 N
Side force	234 N
Twisting Moment	167 N m

Maximum forces exerted on a supporting structure as a result of wind (survival rating) from the most critical direction for each parameter. These values may not occur simultaneously. All forces are referred to the mounting pipe of 115 mm diameter.

↘ Electrical Characteristics

Frequency range	12.7 - 13.25 GHz
Gain, low band	30.8 dBi
Gain, mid band	31.1 dBi
Gain, top band	31.4 dBi
Return Loss	17.7 dB
VSWR	1.3
HPBW	4.6°
Front to back ratio	57 dB
Isolation	35 dB
XPD	30 dB
Electrical Compliance	Class 3
	ETSI 302 217

↘ Shipping Information

Gross weight	12 Kg
Height	400 mm
Depth	400 mm
Width	600 mm

