

Antenna THP 18-127 S

 Antenna THP 18-127 S



▾ General Specifications

Diameter	1.8m
Standard Colour	RAL 7035
Shroud	Standard profile
Antenna Input	Interface for IEC waveguide R 120
Polarization	Single

▾ Mechanical Characteristics

Pole	115 mm
Elevation-fine adjustment	+/- 15 deg
Azimuth-fine adjustment	+/- 10 deg
Side struts, included	1
Side struts, optional	1
Net weight	85 Kg
Radome	Rigid plastic
Wind velocity Operational	180 Km/h
Wind velocity Survival	250 Km/h
Wind deflection	<0.3 times the -3 dB beamwidth
(with a wind velocity of 45 m/s)	Specified wind deflection applies for mm dia mounting pipe only

↙ Antenna Dimensions

(pole mount included)

Height	1878 mm
Width	1878 mm
Depth	1098 mm

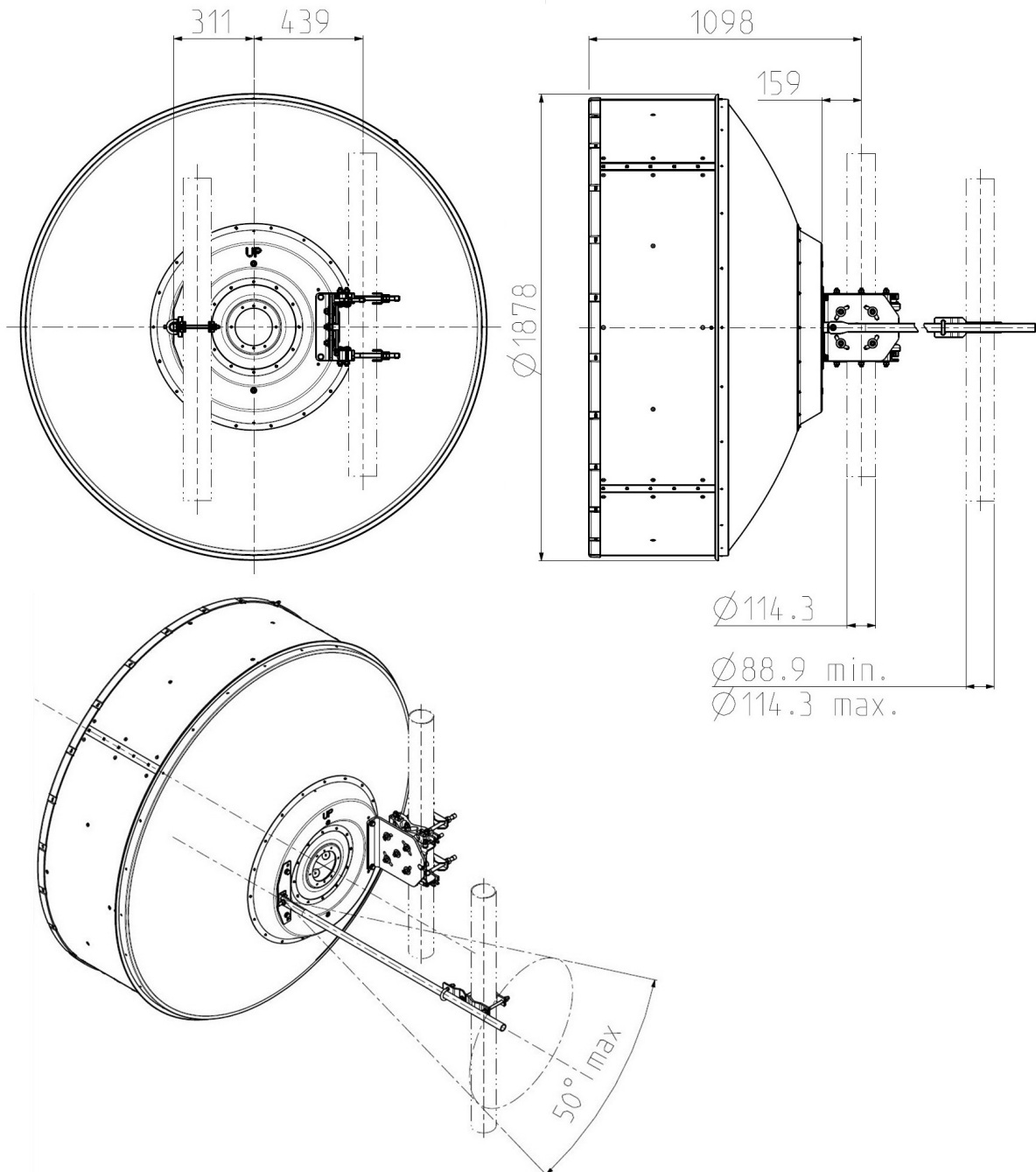

↘ Wind forces at wind velocity survival rating and with 25 mm (1") ice load

Axial force	11094 N
Side force	5495 N
Twisting Moment	5550 N*m

Maximum forces exerted on a supporting structure as a result of wind (survival rating) from the most critical direction for each parameter. These values may not occur simultaneously. All forces are referenced to the mounting pipe (diameter 115 mm)

↘ Electrical Characteristics

Frequency range	12.7 - 13.25 GHz
Gain, low band	45.2 dBi
Gain, mid band	45.5 dBi
Gain, top band	45.8 dBi
Return Loss	17.7 dB
VSWR	1.3
HPBW	0.9°
Front to back ratio	71 dB
Isolation	NA
XPD	30 dB
Electrical Compliance	Class 3
	ETSI 302 217

↘ Shipping Information

Gross weight	130 Kg
Height	2090 mm
Depth	600 mm
Width	1970 mm

