

# Antenna THP 18- 142 DI

&nbsp;Antenna THP 18-142 DI

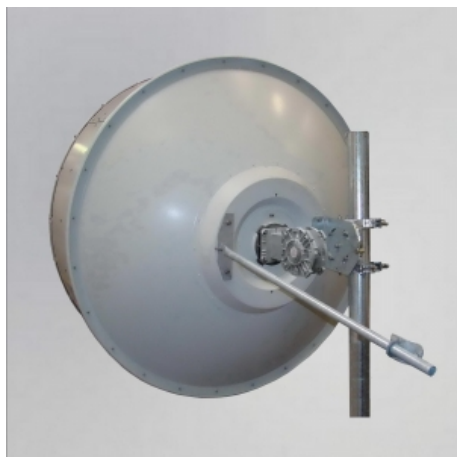

## ▾ General Specifications

Diameter	1.8m
Standard Colour	RAL 7035
Shroud	Low profile
Antenna Input	Interface for IEC waveguide R 140
Polarization	Dual

## ▾ Mechanical Characteristics

Pole	115 mm
Elevation-fine adjustment	+/- 15 deg
Azimuth-fine adjustment	+/- 10 deg
Side struts, included	1
Side struts, optional	1
Net weight	90 Kg
Radome	Rigid plastic
Wind velocity Operational	180 Km/h
Wind velocity Survival	250 Km/h
Wind deflection	<0.3 times the -3 dB beamwidth
(with a wind velocity of 45 m/s)	Specified wind deflection applies for mm dia mounting pipe only

## Antenna Dimensions

(pole mount included)

Height	1880 mm
Width	1880 mm
Depth	1284 mm

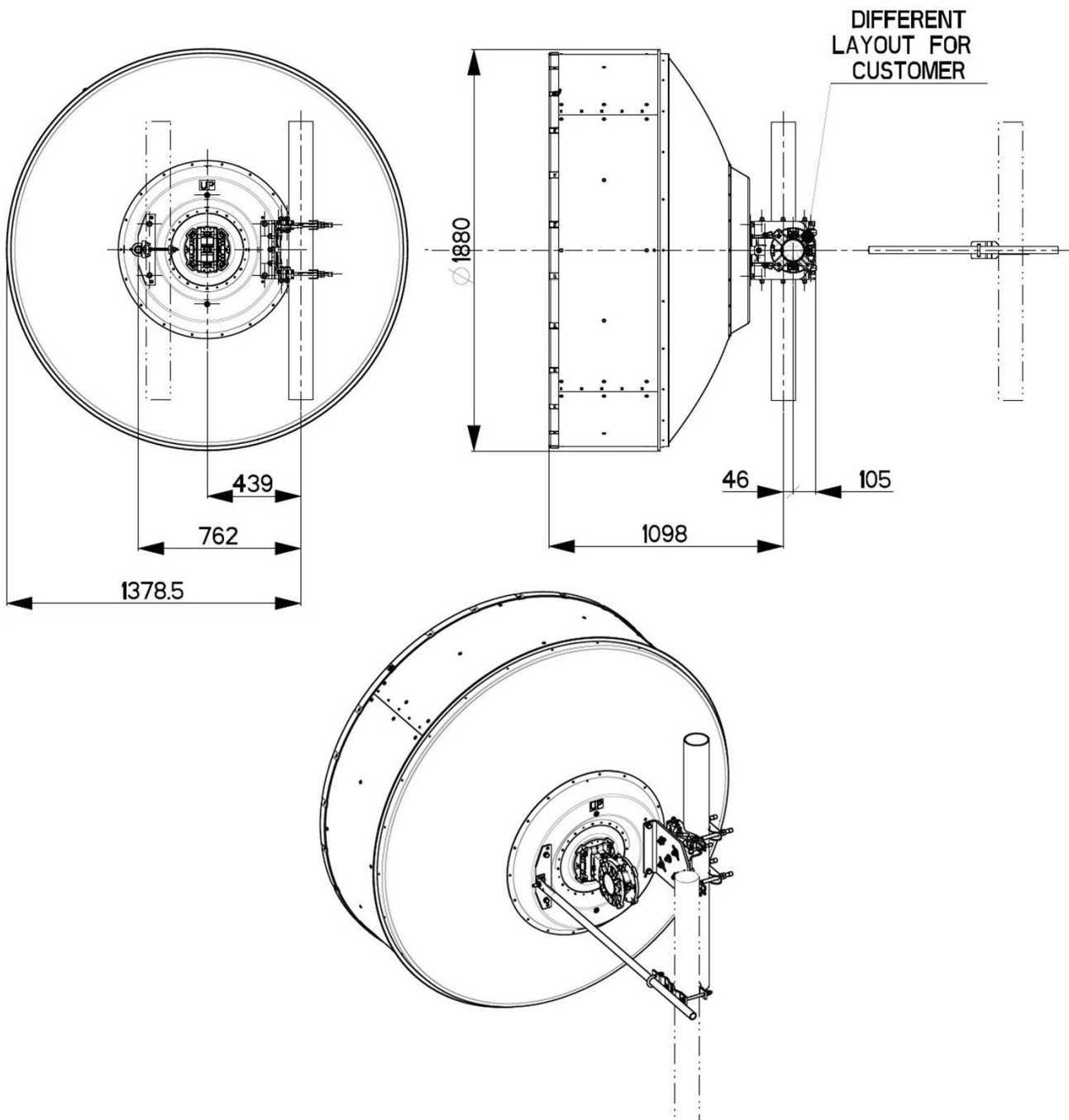

## ↘ Wind forces at wind velocity survival rating and with 25 mm (1") ice load

Axial force	11094 N
Side force	5495 N
Twisting Moment	5550 N*m

Maximum forces exerted on a supporting structure as a result of wind (survival rating) from the most critical direction for each parameter. These values may not occur simultaneously. All forces are referenced to the mounting pipe (diameter 115 mm)

## ↘ Electrical Characteristics

Frequency range	14.2 - 15.35 GHz
Gain, low band	45.5 dBi
Gain, mid band	45.8 dBi
Gain, top band	46.1 dBi
Return Loss	17.7 dB
VSWR	1.3
HPBW	0.8°
Front to back ratio	74 dB
Isolation	35 dB
XPD	30 dB
Electrical Compliance	Class 3
	ETSI 302 217

## ↘ Shipping Information

Gross weight	135 Kg
Height	2090 mm
Depth	600 mm
Width	1970 mm

