

Antenna THP 08 171 D

Antenna THP 08 171 D



▾ General Specifications

Diameter	0.8m
Standard Colour	RAL 7035
Shroud	Low profile
Antenna Input	Interface for IEC waveguide R 220
Polarization	Dual

▾ Mechanical Characteristics

Pole	115 mm
Elevation-fine adjustment	+/- 15 deg
Azimuth-fine adjustment	+/- 20 deg
Side struts, included	0
Side struts, optional	1
Net weight	17.5 Kg
Radome	Rigid plastic
Wind velocity Operational	30 m/s (with optional strut Kit 45 m/s)
Wind velocity Survival	70 m/s
Wind deflection	<0.3 times the -3 dB beamwidth
(with a wind velocity of 30 m/s)	Specified wind deflection applies for 115 mm dia mounting pipe only

↙ Antenna Dimensions

(pole mount included)

Height 842 mm

Width 814 mm

Depth 434 mm

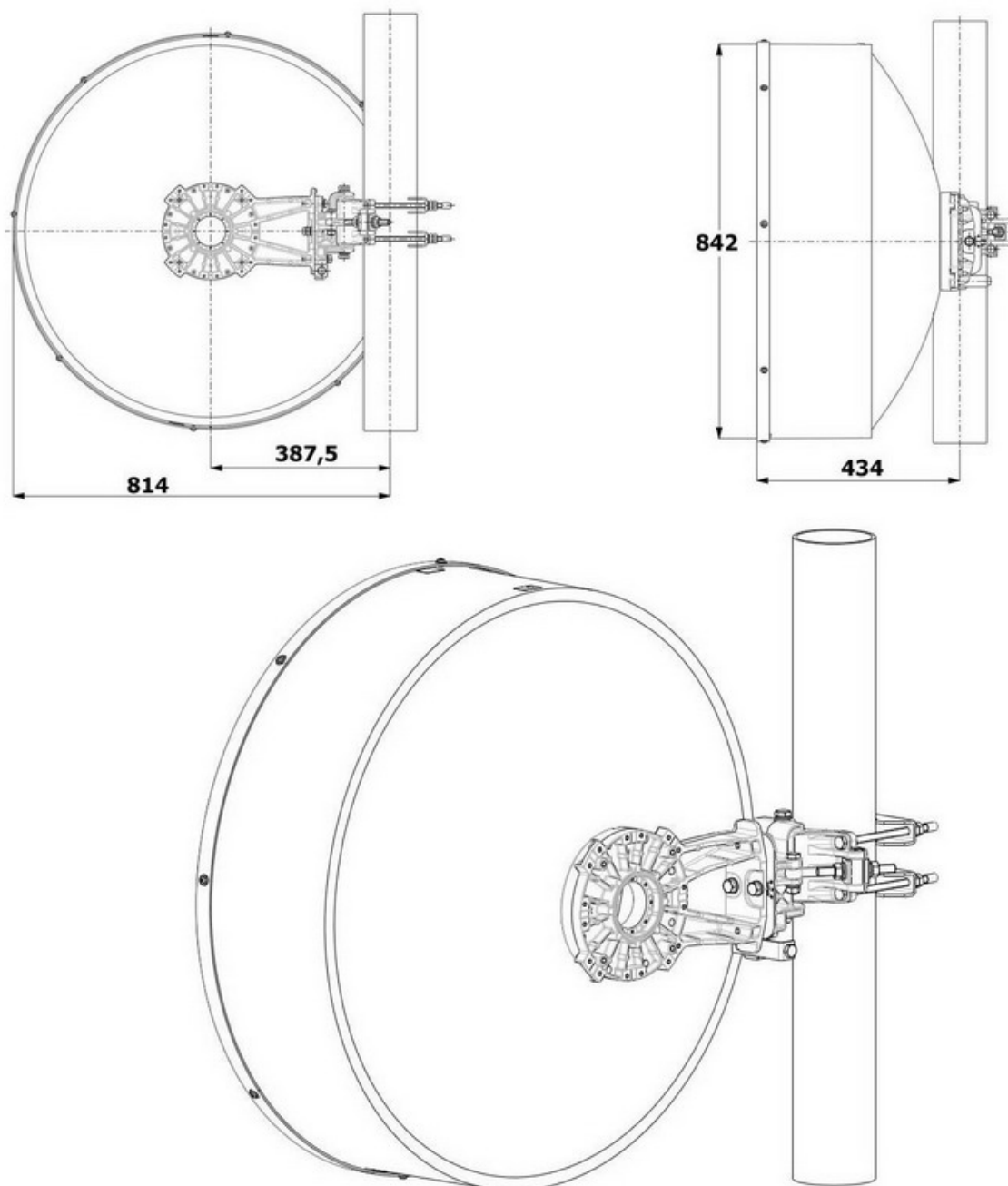

↘ Wind forces at wind velocity survival rating and with 25 mm (1") ice load

Axial force	2230 N
Side force	1105 N
Twisting Moment	821 N m

Maximum forces exerted on a supporting structure as a result of wind (survival rating) from the most critical direction for each parameter. These values may not occur simultaneously. All forces are referred to the mounting pipe of 115 mm diameter.

↘ Electrical Characteristics

Frequency range	17.1 - 17.3 GHz
Gain, low band	40.3 dBi
Gain, mid band	40.4 dBi
Gain, top band	40.5 dBi
Return Loss	14.0 dB
VSWR	1.5
HPBW	1.9°
Front to back ratio	70.0 dB
Isolation	35.0 dB
XPD	30.0 dB
Electrical Compliance	Class 3

↘ Shipping Information

Gross weight	26 kg
Height	700 mm
Depth	920 mm
Width	930 mm

